

omnitec

adapting to hotels

IN-ROOM SAFES ▶ LOCKS ▶ MINI BARS

Room complements and bathrooms accessories



OMNITEC 
adapting to hotels

Welcome to **OMNITEC**, a company dedicated to **guaranty the security in hotel establishments**.

We are specialistic in offering **technological and security solutions to hotels**. We take responsibility of one of the most important pillars in a Hotel: the security of its guests. Thus, thanks to our **in-room safes** and to our **electronic locks** of the latest technology and the most complete **mini bars** catalogue, the hotels provide to their guests an absolute peace of mind and therefore, a pleasanter stay.

Europe

Hotel Silken Berlín**** Berlín, Germany
Holiday Inn Coquelles***Calais, France
Eiffel Seine Hotel*** Paris, France
Rogner Hotel & SPA Lotus Therme ***** Hungary
Airport Hotel*** Budapest, Hungary
BB Hotel Porto **** Portugal
Hotel Axis Porto, Hotel Axis Viana, Porto**** Portugal
Westbury Hotel, UK
Holiday Inn Notting Hill, UK
Cavendish hotel, UK
Hotel Amara Ialomita***, Rumania
Motel Bucium Iasi***, Rumania
Hotel Romanov, Serbia-Montenegro
W Hotel Barcelona *****, Barcelona
Barcelo Punta Umbria Hotel**** Huelva
Barceló Asia Gardens Hotel***** Benidorm
Eco Alcalá Suites Hotel, Madrid
Silken Puerta América Hotel*****, Madrid
Eco Hotel Puerto de Ojén, Ojen, Málaga
Iberostar Albufera Park Hotel****Mallorca
Lux Hotel, Mallorca
Aguait Grupotel, Mallorca
Pachá Hotel**** Ibiza
Citadel Inn, Lvov, Ucrania
Hotel Poltava, Ucrania
Hotel Rus*** Kiev, Ukraine

Some of our **last references** of hotels with our products worldwide

America

Hotel Bristol**** Buenos Aires, Argentina
Hotel Sofitel**** Buenos Aires, Argentina
Maran Suites & Towers*****, Paraná, Argentina
Howard Jhonson***** Rio, Córdoba, Argentina
Hotel W Santiago***** Santiago de Chile
Hotel Meliá Patagonia**** Puerto Varas, Chile
Hotel Sheraton Viña del Mar*****Chile
Hotel Medellín Royal***** Medellín, Colombia
Hotel Pavillon Royal***** Bogotá, Colombia
Hotel Barceló Langosta Beach Resort****,C.Rica
Hotel City Plaza*** Guayaquil, Ecuador
Howard Johnson El Almendral***** Loja, Ecuador
Dreams Cancun****, Cancún, México
Hotetur Beach Paradise****, Cancún, México
Grand Palladium Jamaica Resort****(Fiesta Group), Jamaica
Aranwa Hotel Boutique*****Cuzco, Peru
Aranwa Sacred Valley & Wellness*****Urubamba, Peru

Africa and Asia

Hilton Alexandria Green Plaza*****Alexandria, Egypt
MELIA SHARM, Sharm El Seikh*****, Egypt
Laguna Beach and Spa Hotel****, Mauritius
Novotel Festac Lagos***Festac, Niger
The Franklin Hotel and Suites****, Niger
Radisson Sas Hotel*****Muscat, Oman
City Seasons Hotel Dubai****Dubai, UAE
Sharaf Protea Hotel****Dubai, UAE
City Seasons Hotel Al Ain*** Al Ain, UAE

History

In 2005 Omnitec was founded as a Hotel Division inside the BTV company. The more than 25 years of experience that the group has as a pioneers and manufacturers of **technology applied to security**, have guaranteed the success of our locks and our access management systems using our own technologies.

The growing hotel market together with the good quality product, forced the creation of a new independant company in 2008, OMNITEC SYSTEMS,S.L, in order to offer an **optimun service** to the hotel customer. New departments were established with a working team specialized in hotel security.

We are proud to announce that we have obtained the Quality Management System Certification of the UNE-EN-ISO 9001:2008 Norm for our SAFES, MINIBARS and LOCKS for hotels. We have passed successfully the ISO:9001 The scope of certification includes With the ISO 9001:2008 (International Standards Organization),audit by the certification authority TÜV Rheinland Ibérica Inspection, Certification & Testing S.A, for **development and distribution of safes, minibars and locks for hotels**, we aim to ensure and continuously improve the control of all its processes and differentiate in the market through greater management efficiency.

Today, OMNITEC SYSTEMS, develops and commercialize this catalogue products adapting them to hotels. If you find something missing, please do not hesitate to tell us and we will work to satisfy your needs.

The Omnitec Team

Omnitec, the brand.....

2.

in-room safes.....

4.

electronic locks.....

8.

access management.....

12.

mini bars

14.

room complements and.....
bathroom accessories

18.

Easy

opening by code



EASY Laptop 15

Features

- ✓ Motorized opening system by 3 to 6 digits user code
- ✓ Flat digital keypad with 2 languages operating instructions
- ✓ Braille and acoustic indicators especially designed to help its use by disabled persons
- ✓ Emergency opening by master code and mechanical key
- ✓ Emergency lock hidden by a removable and customizable magnet

Construction and finishing

- ✓ Solid carbon steel construction
- ✓ Ultra reliable 2 chromed steel bolts of 20 mm. diameter
- ✓ Wide opening hinges to ease the laptop entry
- ✓ Elegant anti-corrosion paint
- ✓ Interior carpet
- ✓ Screws and holes in depth and base to be fixed and installed in-wall, floor, closets or shelves
- ✓ Battery operated by 4 alkaline batteries AA

standard features

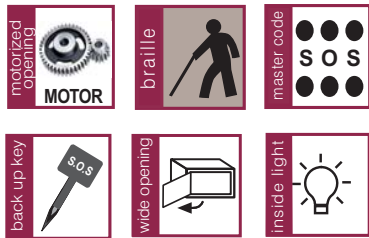

available dimensions

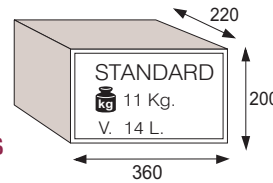

recommended for general uses (wallet, cash, credit cards, video and photo cameras, etc)

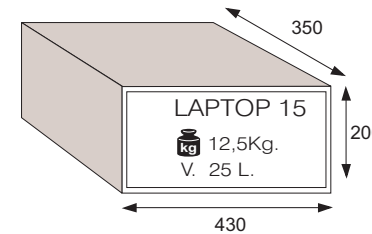

recommended for general uses and up to 15,4" laptop size

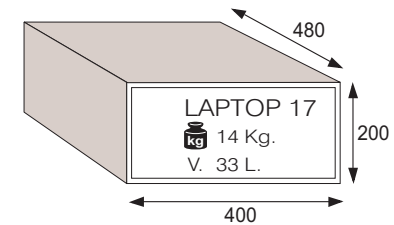

recommended for general uses and up to 17" laptop size

options upon request

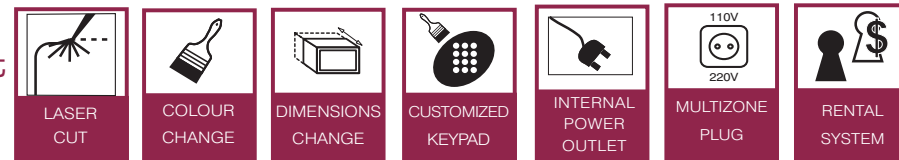

Easy plus

opening by code



EASY PLUS Laptop 15

standard features

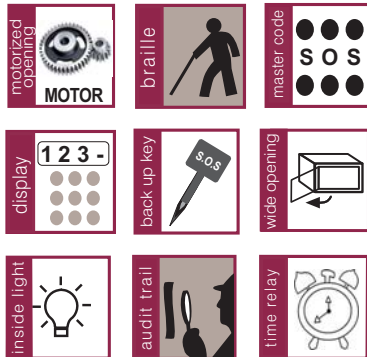

available dimensions

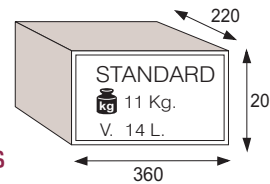

recommended for general uses (wallet, cash, credit cards, video and photo cameras, etc)

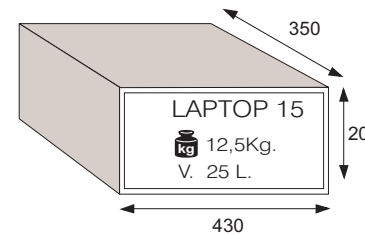

recommended for general uses and up to 15,4" laptop size

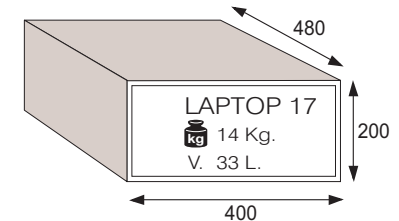

recommended for general uses and up to 17" laptop size

options upon request

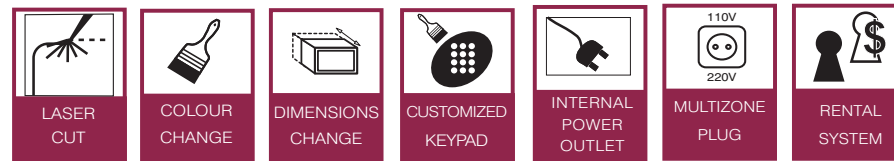

Features

- ✓ Motorized opening system by 3 to 6 digits user code
- ✓ Flat digital keypad with 2 languages operating instructions
- ✓ Acoustic indicators and leds especially designed to help its use by disabled persons
- ✓ Emergency openings with **audit trail function** by master code (with relay programmable option), and mechanical key
- ✓ Emergency lock hidden by a removable and customizable magnet
- ✓ Audit trail reporting function identifying all safe openings and closings executed. They can be printed by a compact printer

Construction and finishing

- ✓ Solid carbon steel construction
- ✓ Ultra reliable 2 chromed steel bolts of 20 mm. diameter
- ✓ Wide opening hinges to ease the laptop entry
- ✓ Elegant anti-corrosion paint
- ✓ Interior carpet
- ✓ Screws and holes in depth and base to be fixed and installed in-wall, floor, closets or shelves
- ✓ Battery operated by 4 alkaline batteries AA

Supra



opening
by code
or card



Supra laptop 15

standard features

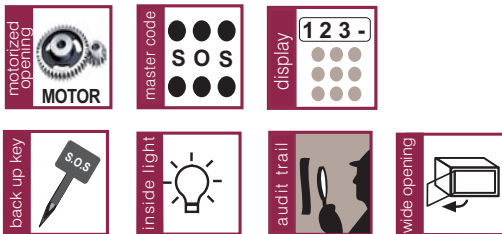

black colour



grey - black
colours option

Features

- ✓ Motorized opening system by 3 to 6 digits user code or by credit card
- ✓ keypad with screen with led light and card slot
- ✓ Acoustic indicators and leds especially designed to help its use by disabled persons
- ✓ Mechanical emergency opening by key
- ✓ Electronic emergency opening by handheld unit + code or only the code
- ✓ Optional audit trail reporting function identifying all safe openings and closings executed printed by a compact printer conected to safe
- ✓ Handheld unit to be used to:
 - . Power outlet when low batteries
 - . Electronic emergency opening with a security code
 - . Openings and closings data compilation for its PC audit trail by the software included



Construction and finishing

- ✓ Solid carbon steel construction
- ✓ Ultra reliable 2 chromed steel bolts of 20 mm. diameter
- ✓ Wide opening hinges to ease the laptop entry
- ✓ Elegant anti-corrosion paint
- ✓ Interior carpet
- ✓ Screws and holes in depth and base to be fixed and installed in-wall, floor, closets or shelves
- ✓ Battery operated by 4 alkaline batteries AA



audit trail printer

available dimensions

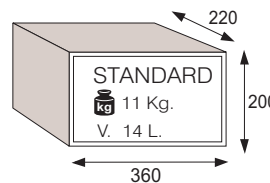

recommended for general uses (wallet, cash, credit cards, video and photo cameras, etc)

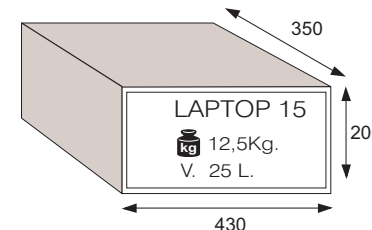

recommended for general uses and up to 15,4" laptop size

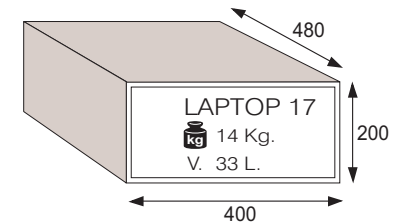

recommended for general uses and up to 17" laptop size

options upon request

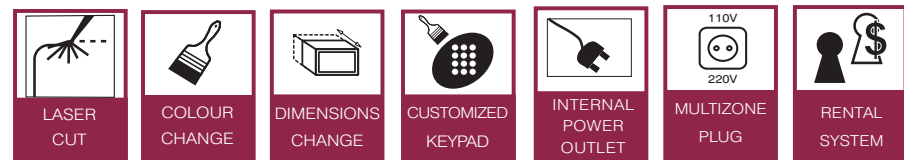

Diva

opening by code



DIVA folder

standard features

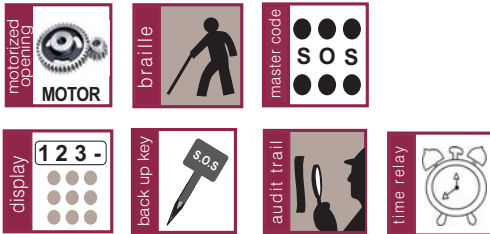

Features

- ✓ Motorized opening system by 4 or 6 digits user code
- ✓ Flat digital keypad with display in 2 languages operating instructions
- ✓ Acoustic indicators and leds especially designed to help its use by disabled persons
- ✓ Emergency openings with **audit trail function** by master code (with relay programmable option), and mechanical key
- ✓ Audit trail reporting function identifying all safe openings and closings executed. They can be printed by a compact printer
- ✓ Electronic rental system by software e-Rent, as an option

Construction and finishing

- ✓ Solid carbon steel construction
- ✓ Ultra reliable 2 chromed steel bolts of 20 mm. diameter
- ✓ Hidden hinges
- ✓ Elegant anti-corrosion paint
- ✓ Interior carpet
- ✓ Screws and holes in depth and base to be fixed and installed in-wall, floor, closets or shelves
- ✓ Battery operated by 4 alkaline batteries AA

available dimensions

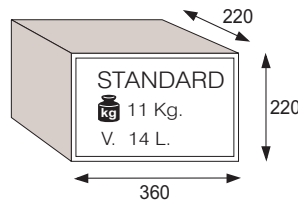

recommended for general uses (wallet, cash, credit cards, video and photo cameras, etc)

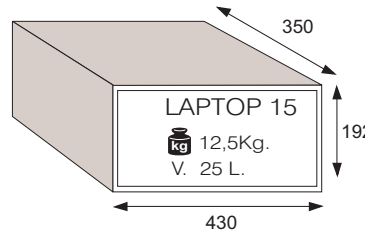

recommended for general uses and up to 15,4" laptop size

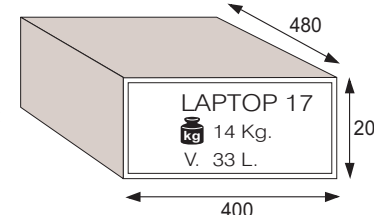

recommended for general uses and up to 17" laptop size

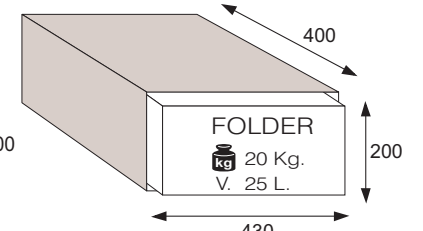

Drawer type opening by sliding guides. Recommended for general uses and up to 15,4" laptop size

options upon request

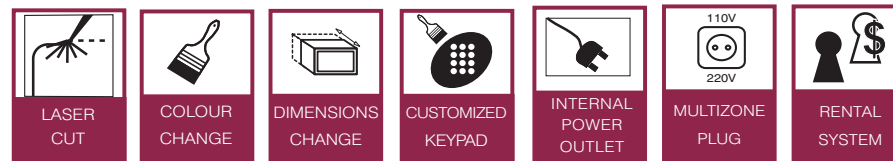

Gaudi

13,56 Mhz
PROXIMITY MIFARE



MIFARE proximity opening technology together with a neat aesthetic consolidate in a lock made in high quality materials which is designed to satisfy the decorative needs of any living space.

STAINLESS STEEL AISI 304

opening systems



✓ PROXIMITY MIFARE

emergency opening

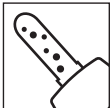

✓ MECHANICAL KEY

Its use is shown when the lock is audited.



✓ ELECTRONIC WITH HANDHELD UNIT

fire resistance



access management



✓ GESTHOTEL

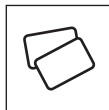

✓ SIMPLEX



Inside room view





✓ **HANDHELD UNIT** for lock set up
 Lock audit trail (room number, suite number, common doors, valid working hours, authorized staff, black lists openings, batteries report, etc...)





✓ **MIFARE BRACELET**
 Comfort for the openings and access control.
 Water resistant to assure its perfect working in spa, sauna, jacuzzi, swimming pools and other water sports activities. Many models available.

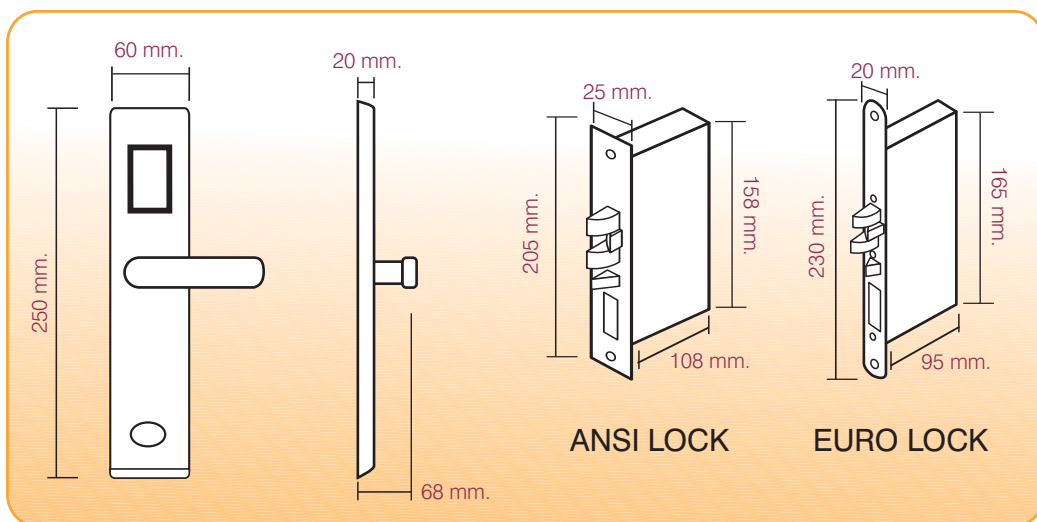

MONTCALM HOTEL, London (UK)
 Gaudí Proximity locks



available finishings:

-  STAINLESS STEEL
 AISI 304
 natural finishing
-  STAINLESS STEEL
 AISI 304
 gold finishing



Goya

A lock with timeless and classic design that gives the right look for any hotel atmosphere

opening systems

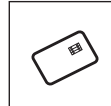

✓ CHIP CARD



✓ DUAL TECHNOLOGY



✓ PROXIMITY MIFARE

access management



✓ GESTHOTEL

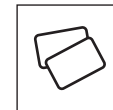

✓ SIMPLEX

mechanical emergency opening

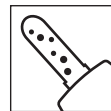

✓ MECHANICAL KEY

Its use is shown when the lock is audited.

fire resistance



Goya dual or chip



INDALIA GARDEN HOTEL
Almería, Spain
Goya dual locks

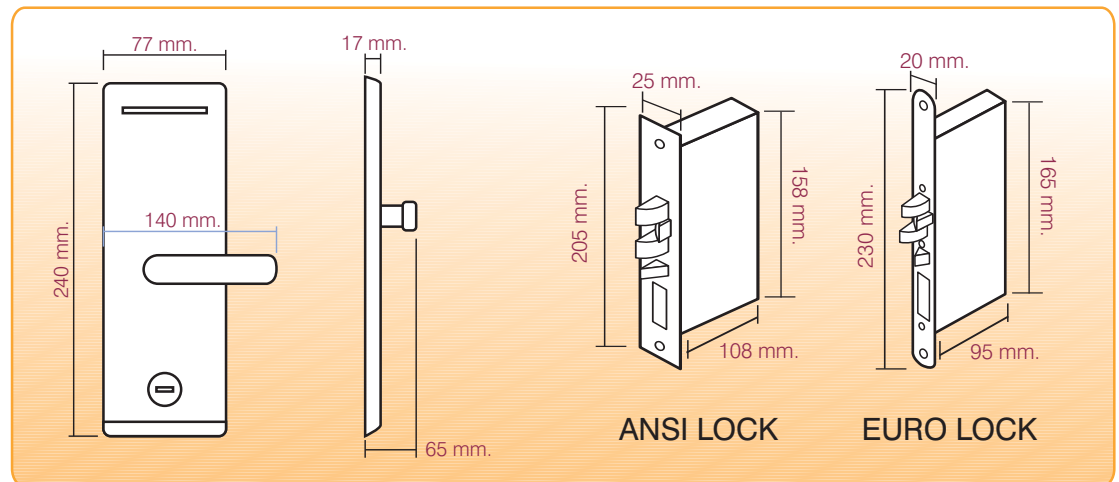

Our Locks...

Our locks offer security, technology, experience and service

- ✓ Fire certification, complying the current standard which provides a fire spread resistance.
- ✓ They have an anti-panic latch that operates from the interior in order to facilitate emergency exits and prevent undesired entry.
- ✓ They incorporate the latest opening system technologies: PROXIMITY (MIFARE), Magnetic card and SMART.
- ✓ Damp-proof electro-circuit allows the use in all environments.
- ✓ They allow emergency opening with a key, wich can be audited*.
- ✓ They operate with 4 AA batteries. They incorporate acoustic indicator of low battery for hotel staff.
- ✓ Thanks to incorporation of real-time clock, is possible to manage staff and guest accesses and audit the last 250 openings made with any kind of card or emergency key*.
- ✓ Non-volatile EPROM memory for maintaining memory during battery changes.

* Except for the Simplex system.

new 13,56 Mhz
PROXIMITY MIFARE



Goya Proximity MIFARE

available finishings:

 STAINLESS STEEL
AISI 304
natural finishing

 STAINLESS STEEL
AISI 304
gold finishing

Access Control

An efficient access management system adapted to the hotel's needs, improves notably the image of a modern, controlled and secure hotel, giving your customers peace of mind.

G E S T H O T E L

- ✓ Operate on WINDOWS® environment.
- ✓ Compatible with any hotel management software on the market that works in this environment.
- ✓ For hotels from 1 to 10.000 rooms.
- ✓ For SECURITY, it incorporates a unique and different identifier for every hotel, thereby preventing cards from being coded for or at other hotels.
- ✓ It has various access levels to the program, with different operating permissions.
- ✓ It manages and controls guest accesses to rooms, safes, parking areas, etc., thereby allowing additional benefits through its use.
- ✓ It manages and controls accesses by both daily operational staff and emergency personnel.
- ✓ In the event of the loss or theft of the cards, new ones can be generated that disable the original card, without having to reprogram the locks.
- ✓ Management and effective control of room occupancy and reservations, including a registration log.
- ✓ It has remote control technical service by internet.

S i m p l e x

The advantages of the traditional key applied to electronic card locks. Ideal for hotels that are not willing to give up the COMFORT, TECHNOLOGY and SECURITY provided by electronic locks.

- ✓ No PC required.
 - ✓ Accesses are managed using cards coded at OMNITEC, which are unique and cannot be copied. A MASTER card enables access to rooms and GUEST and HOTEL STAFF areas.
 - ✓ It allows subsequent migration to GESTHOTEL or CONTROL EDITOR.
 - ✓ Two lock programming modes:
 - ✓ Each guest card is identified with a room. Therefore, during the initial installation, the MASTER card is inserted first and then the GUEST card. It is advisable to request that the card be returned at check-out.
 - ✓ Whenever a guest arrives, the lock is programmed.
- At that time, the MASTER card is inserted, and then the GUEST CARD.
- ✓ If cards are lost or stolen, the MASTER card disables the misplaced card and allows new access with a new card, thus providing your hotel with MAXIMUM SECURITY.

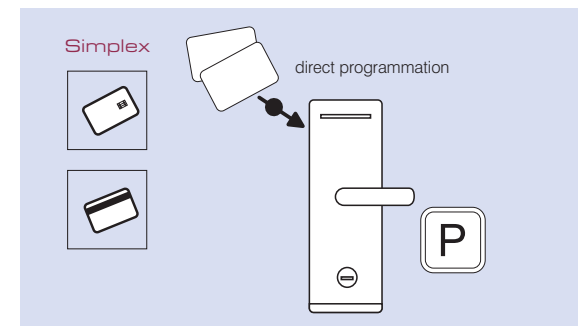



Energy savers

The OMNITEC energy savers prevent indiscriminate energy consumption by your customers. A considerable savings of energy expenses is thus obtained, thereby contributing to environmental conservation.



- ✓ **Simple energy saver.** By inserting any card, the use of electric energy in the room is enabled. Optionally, when the card is removed, the electric energy is shut off with a 15 second delay.
- ✓ **"Intelligent" energy saver.** Only by inserting the access card in the lock is the use of electric energy allowed, thereby ensuring greater energy savings. The delay time for energy shut-off after removing the card can be programmed by the hotel.

Small details save money

Access control

OMNITEC complete the electronic lock system control with its access control to common or restricted areas.

With the same room card, only your previously authorized guests will be able to enjoy the common areas of the hotel such as the parking area, pools, Gym etc. or private rooms such as the manager office.

OMNITEC offers room locks and wall card readers specifically programmed for the use of the previously authorized guests and/or staff members. With only one codified room card, the guest or employee will have access to different hotel properties or areas during specific hours previously programmed.

The access controls could be audited in order to control the undesired people entrances and exists



embedded access control made in stainless steel



New Proximity MIFARE reader

Electronic lockers proximity MIFARE

OMNITEC electronic lockers are equipped with the proximity technology MIFARE. There are 2 different kind of lockers:



Reader and inside mechanism

- ✓ **STAFF LOCKERS**, methalic made, there are used to keep the personel belongings during the working hours.
- ✓ **GYM AND SPA LOCKERS**, phenolic made high resistance against humidity, Those special ones are recommended to the use of hotel guests in order to keep their belongings safely whenever ther are using Gym, Spa, Sauna...and other hotel areas.

See more details and specifications in our OMNITEC lockers brochure.

The range of OMNITEC mini bars, complete and wide because of the used refrigerating technologies and the possibilities of configuration allowed is a sector reference today, providing the most adequate product for every single necessity. Our ABSORPTION minibars are the perfect combination of the traditional style and vanguard lines mini bar, totally silent and full featured (opposite to the other mini bar brands which have this as an option), low consumption and with all the new customizing possibilities.

Because customer loyalty is the key driver of our business, In OMNITEC we adapt to hotel needs and requests providing customers with a high level of service



Black body and genuine steel door



Silver body and genuine steel door

Standard colours

Other colours upon request

Absorption: the traditional means of refrigeration for your hotel

- Economic:** from 0,75 kW/24 hours.
- Silent:** no moving parts.
- Profitable:** Zero maintenance.



The absorption minibar series **A-PLUS** of OMNITEC, is the perfect solution for those hotels looking for a high standard ones together with a traditional style. Full featured, they offer the maximum service to their guests in a totally silent and efficient way, and with low electric consumption for the hotel. With the customizable design option of the **A-PLUS** series, their fittings and possibilities of configuration assure a distinctive room atmosphere

Absorption A-Plus

A Plus, the most innovative minibar



Full featured



AUTODEFROST



Smart thermostat with temperature sensor



Transparent shelves adjustable in height



Transparent bottle supporters adjustable in height and depth



Low consumption inner LED light.



minibar A-Plus 40
black / silver



Infinity of colours and wood finishings to choose. Ask us



Barceló Pueblo Menorca Hotel
Islas Baleares, SPAIN
minibars A-Plus 40

Absorption A and A-Plus



A-Plus 40 silver

✓ DOOR OPENING CONTROL LED (OPTION)

✓ COMFORTABLE DOOR HANDLE

The Transparent bottle supporters improve the product presentation and promote the drinks to be consumed



✓ GLASS DOOR option

NEW customizable glass door
BEAUTY AND DISTINCTION



✓ Customized GLASS DOOR option

OMNITEC PRODUCT HERE

HOTEL W BARCELONA
Minibars A-40 Plata
DOOR OPENING CONTROL LED



Omnibar A-30 / A-40 A-Plus 30 / A-Plus 40

Capacity:	30 L. / 40 L.
Temperature:	1 -7 C°
Consumption:	0.8 kW./ 24 h.
Wattage:	60 W.
Voltage:	110 / 240 V.

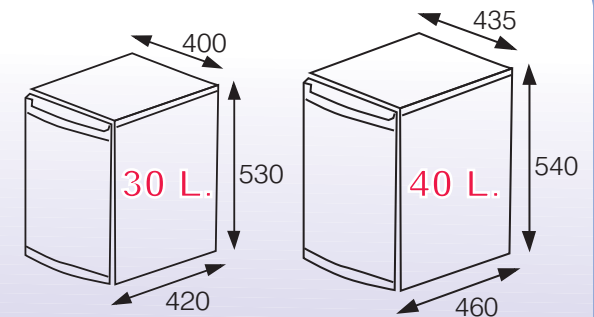

OPTIONS UPON REQUEST

- 
 ✓ GLASS DOORL
- 
 ✓ CUSTOMIZED GLASS DOOR
- 
 ✓ DOOR OPENING CONTROL LED
- 
 ✓ LOCK
- 
 ✓ WHEELS

Customize your minibar



Use your imagination to create a unique minibar
It allows serigraphies and photos to be printed



✓ LOCK option

Because at OMNITEC we want to guarantee the maximum satisfaction of our clients, it is necessary to take into account the minimum conditions needed for installation before investing in a mini bar, thus ensuring the maximum performance and a long useful life of the appliance.

Ventilation system

The refrigeration systems located at the back of the mini bars need a correct ventilation in order to expel the heat that they generate. This is why air circulation is needed, more specifically an entrance for the air underneath the mini bar. The air can then flow under and along the mini bar until reaching the refrigerant system and escape through a hot air exit at the top.

To make installation easier, OMNITEC can provide grilles to be inserted into the appropriate furniture so that the minibars can work correctly. Please ask us for them.

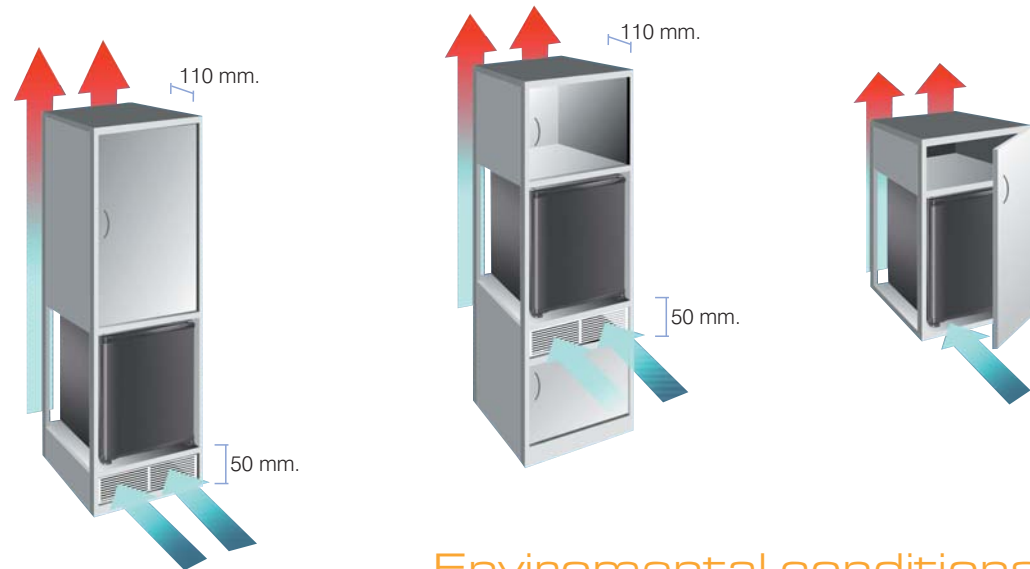

Environmental conditions

The lack of air conditioning will have a decisive effect on the performance of the mini bar. Extreme heat in the rooms will mean that the difference in temperature between the heat given off by the refrigerant device and the room temperature is minimum. In this way it is not possible to achieve the suitable ventilation of the mini bar.

At OMNITEC we are at your complete disposal to answer all your questions. By taking into account our recommendations your guests will feel completely at home in your hotel.

Hairdryers



Hydra
1200 W
dimensions (mm):
206 X 158 X 97
Automatic stop
and 2 speed



Reiki
1200 W
dimensions (mm):
210 X 153 X 90
Automatic stop
and 2 speed



Aqua
1350 W
dimensions (mm):
180 X 195 X 108
2 speed



Wellness
+1200 W
Automatic stop
and 2 speed

on/off switch with led indicator.

Multizone socket for low wattage devices



Spa
700 W
dimensions(mm):
600 X 200 X 90
Wattage regulator

Magnifying mirrors



Mod.1
1 arm
Chromed brass
x2.5 magnifying
Diameter: 180 mm.



Mod.2
2 arms
Chromed brass
x2.5 magnifying
Diameter: 180 mm.

Bins

Capacity:
12, 5, and 3 Lts.
Shine stainless steel



available in
other colours



Luggage racks



**Luggage rack
natural colour wood**
folded dimensions: 610 x 740 x 30
open dimensions :610 x 370 x 530
weight: 1,78 kg.



Luggage rack chromed / golden, steel

folded dimensions: 610 x 700 x 60
open dimensions: 610 x 420 x 520
weight: 2,32 Kg.



**Luggage rack
varnished wengé wood colour**
folded dimensions: 600 x 630 x 100
open dimensions: 630 x 425 x 420
weight: 1,85 kg.



Genova

Shine stainless steel



composed by

- 1 Ring towel
- 2 Towel shelf
- 3 Towel bar
- 4 Hanger
- 5 WC Paper holder
- 6 WC Paper holder spare*
- 7 Toilet brush

* available in some models

SAFETY BARS

SHINE finished (B)
POLISHED finished (M)

- mod.B1/ M1: 25 x 305 mm
- mod.B2/ M2: 25 x 457 mm
- mod.B3/ M3: 25 x 508 mm
- mod.B4/ M4: 25 x 610 mm

mod.B5: 25 x 457 mm

mod.M5: 25 x 457 mm

Marina

Shine stainless steel



610mm

Telmo

Polished stainless steel



610mm



Headoffice:

Ctra. Nacional II km.333, Polígono BTV

C/ Tamariz, 9

50171 La Puebla de Alfindén

Zaragoza (Spain)

telf. +34 976 107201 Fax +34 976 455578

info@omnitec.es

GPS Position: 41°38'30".00 N
0°46'16".00 W

www.omnitec.es

www.adaptingtohotels.com